



ROTAIR®

PORTABLE

COMPRESSORS

SCREW
SUPERSILENT
for civil
engineering

DS | MDVN | MDVS | VRK | VRH

GENERAL
CATALOGUE



PRO
SERIES





DELIVERING **WORLD CLASS**
Compressed Air Solutions



❏ | **SCREW SET ENTIRELY DESIGNED
AND MANUFACTURED BY ROTAIR**

WITH GROUND PROFILE
OF ROTAIR EXCLUSIVE PATENTED
MANUFACTURE AND DESIGN

FOR OWN USE AND B2B APPLICATIONS.

The asymmetric profile with oil injection is created by means of high pressure grinding that ensures excellent performance of the set in the compression stage, reducing the required energy dispersion to a minimum. The installed screw sets are of direct transmission type without geared rev multiplier. This solution reduces wear of the screw set and overheating, ensures reduced noise emissions and fuel consumption savings.

ROTAIR®



Worldwide
VERSION



*Different features or tech specs may apply
for the European version of this model*

powerful › compact

GOMMAIR 10



- › Industry leading compact, square design
- › Small footprint, no wheels
- › Electro-galvanized bodywork and structure with advanced painting procedure to grant an excellent preservation through time.

- › Easy Service design for maximum accessibility for ease of maintenance.
- › Easy managing with forklift.
- › Quiet and efficient Kubota Stage 3A engine.
- › Pressurized oil circuit to ensure efficient oil lubrication.
- › Air/oil separator filter, can guarantee an excellent air/oil separation.
- › Palletized, can be handled with forklift from all sides.

Technical Data

dimensions >

L = 1015 mm / 40.0"

W = 705 mm / 27.7"

H = 980 mm / 38.5"

weight >

265 kg / 584 lbs

GOMMAIR 10

DO YOU
KNOW

?

COMPRESSOR

Operating pressure	7 bar 100 psi	11 bar 160 psi	13 bar 185 psi
Free air delivery	1100 l/min 39 cfm	930 l/min 33 cfm	800 l/min 28 cfm

DIESEL ENGINE / ENVIRONMENTAL CONDITIONS

Engine make	KUBOTA
Engine type	Z 602
Emissions	Stage V / Tier 4
Displacement	599 cc
N. cylinders	2
Max engine power @3200 RPM	10,8 kW - 14,7 CV
Max engine speed	3200 RPM
Min engine speed	2400 RPM
Cooling system	Water
Fuel tank capacity	13 lt - 2.86 UK gal
Consumes	1,9 lt/h - 0.42 UK gal/h
Max ambient temperature	50°C - 122°F
Max altitude	1800 m a.s.l.
Min working temperature	-10°C / 14°F

...all our
ranges



also
available

AS...

customized
**SANDBLASTING
VERSION**

**INBUILT ADDITIONAL COOLER AND
SPECIFIC CONDENSATE SEPARATOR**

for cool and dry air

- › 1 compressor oil filter.
- › 1 single stage air filter for the compressor part of large size to ensure efficient filtering of air suctioned by the screw unit.
- › Spin-on engine and compressor oil filters for faster and easier maintenance.
- › 1 double stage air filter for the engine.
- › Protective device for engine cold start.
- › Combined radiator allowing both compressor oil cooling and engine liquid cooling.

ROTAR

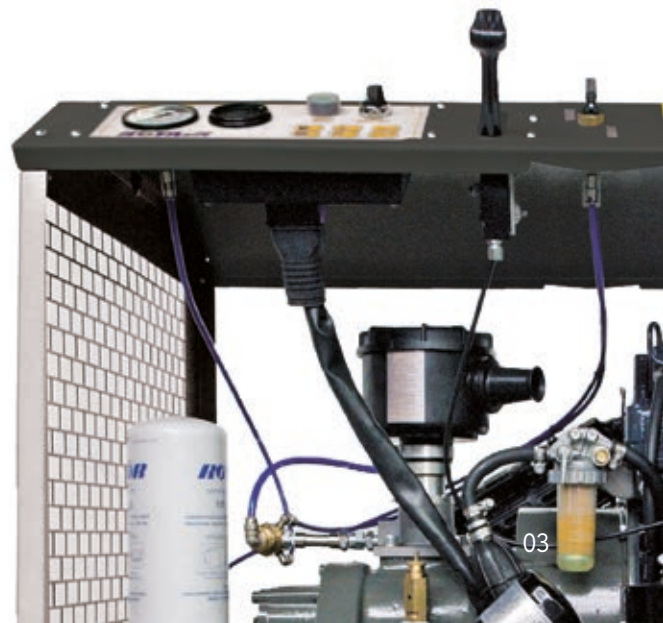

ROTAIR®



Worldwide
VERSION

supersilent ›

DS

powerful › compact

31K-37K



- › Industry leading compact, box-type design.
- › Electro-galvanized bodywork and chassis with advanced painting procedure to grant an excellent preservation through time.
- › Easy Service design for maximum accessibility for ease of maintenance
- › Curbside mounted control panel, adjacent air valves and fluid drains for convenient operation and maximum operator safety.

- › Steel fuel tank, resists cracks, splitting and deformation.
- › Quiet and efficient Kubota Stage 3A engine, without costly DPF System.
- › Exclusive pneumatic control system, developed by ROTAIR, to adjust automatically engine revs, depending on the air to be delivered. This system is highly reliable and ensures fuel consumption saving.
- › Start/Stop "INTELLIGENT SYSTEM", exclusive from ROTAIR, to prevent the risk of incorrect procedures during specific functioning.
- › Lifting hook for crane handling.
- › Palletized, can be handled with forklift from all sides

Technical Data

dimensions >

L = 1650,5 mm / 64.98"

W = 750 mm / 29.53"

H = 865 mm / 34.06"

weight > (with fluids, without fuel)

550 kg / 1213 lbs

DS 31K

dimensions >

L = 1650,5 mm / 64.98"

W = 750 mm / 29.53"

H = 865 mm / 34.06"

weight > (with fluids, without fuel)

550 kg / 1213 lbs

DS 37K

COMPRESSOR

Operating pressure	7 bar - 102 psi
Free air delivery	3000 lt/min - 106 cfm
Minimum working pressure	5 bar - 73 psi
Drive system engine-airend	Direct Drive
Compressor cooling system	Air / Oil
Oil cooling capacity	8 lt - 1.76 UK gal
Air outlet temperature	40°C - 105°F + Ambient temperature
Outlet valves	1 x 3/4"
Battery capacity	12V - 74 Ah - 680 A
Fuel tank capacity	50 lt - 11 UK gal
Consumes	4,4 lt/h - 0.97 UK gal/h (11 working hours)

DIESEL ENGINE / ENVIRONMENTAL CONDITIONS

Engine make	KUBOTA
Engine type	V-1505-E3B
Engine system	4 strokes - Inline
Emissions	Stage III A / Tier 4 Interim
Displacement	1498 cc
N. cylinders	4
Aspiration	Natural
Max engine power @3000 RPM	26,2 kW - 35.0 HP
Max engine speed	3000 RPM
Min engine speed	1600 RPM
Cooling system	Water
Cooling system capacity	5 lt - 1.1 UK gal.
Lubrication system	Oil
Lubrication system capacity	6 lt - 1.32 UK gal
Max ambient temperature	50°C - 122°F
Max altitude	1800 m a.s.l.
Min working temperature	-10°C / 14°F

Operating pressure	7 bar - 102 psi
Free air delivery	3600 lt/min - 127 cfm
Minimum working pressure	5 bar - 73 psi
Drive system engine-airend	Direct Drive
Compressor cooling system	Air / Oil
Oil cooling capacity	8 lt - 1.76 UK gal
Air outlet temperature	40°C - 105°F + Ambient temperature
Outlet valves	1 x 3/4"
Battery capacity	12V - 74 Ah - 680 A
Fuel tank capacity	50 lt - 11 UK gal
Consumes	4,4 lt/h - 0.97 UK gal/h (11 working hours)

Engine make	KUBOTA
Engine type	V-1505-E3B
Engine system	4 strokes - Inline
Emissions	Stage III A / Tier 4 Interim
Displacement	1498 cc
N. cylinders	4
Aspiration	Natural
Max engine power @3000 RPM	26,2 kW - 35.0 HP
Max engine speed	3000 RPM
Min engine speed	1600 RPM
Cooling system	Water
Cooling system capacity	5 lt - 1.1 UK gal
Lubrication system	Oil
Lubrication system capacity	6 lt - 1.32 UK gal
Max ambient temperature	50°C - 122°F
Max altitude	1800 m a.s.l.
Min working temperature	-10°C / 14°F

- › Air/oil separator filter, element inside separator tank, can guarantee an excellent air/oil separation.
- › The air and oil filters of the compressor and the air and oil filters of the engine are independent.
- › Spin-on engine and compressor oil filters for faster and easier maintenance.
- › Single stage oversized air filter for compressor part, to guarantee good filtering of the air intake by airend. Two-stage air filter for engine part.
- › Combined radiator allowing both compressor oil cooling and engine liquid cooling.



ROTAIR®



Worldwide
VERSION



*Different features or tech specs may apply
for the European version of this model*

supersilent ›

DS

powerful › compact

46K-53K



- › Industry leading compact, box-type design.
- › Electro-galvanized bodywork and chassis with advanced painting procedure to grant an excellent preservation through time.
- › One-Side Service design with Spin-on oil and separator filters for ease of maintenance
- › Curbside mounted control panel, adjacent air valves and fluid drains for convenient operation and maximum operator safety.

- › Steel fuel tank, resists cracks, splitting and deformation.
- › Quiet and efficient Kubota Stage 3A engine, without costly DPF System.
- › Exclusive pneumatic control system, developed by ROTAIR, to adjust automatically engine revs, depending on the air to be delivered. This system is highly reliable and ensures fuel consumption saving.
- › Start/Stop "INTELLIGENT SYSTEM", exclusive from ROTAIR, to prevent the risk of incorrect procedures during specific functioning.
- › Lifting hook for crane handling.
- › Palletized, can be handled with forklift from all sides

Technical Data

dimensions >

L = 1730 mm / 68.11"
W = 836 mm / 32.91"
H = 1092,5 mm / 43.01"

weight >

890 kg / 1962 lbs

DS 46K

dimensions >

L = 1730 mm / 68.11"
W = 836 mm / 32.91"
H = 1092,5 mm / 43.01"

weight >

890 kg / 1962 lbs

DS 53K

COMPRESSOR

Operating pressure	7 bar - 102 psi
Free air delivery	4500 lt/min - 159 cfm
Minimum working pressure	5 bar - 73 psi
Drive system engine-airend	Direct Drive
Compressor cooling system	Air / Oil
Oil cooling capacity	10,7 lt - 2.35 UK gal
Air outlet temperature	40°C - 105°F + Ambient temperature
Outlet valves	2 x 3/4"
Battery capacity	12V cc - 750A-100Ah (EN)
Fuel tank capacity	88 lt - 19.36 UK gal
Consumes	6,7 lt/h - 1.47 UK gal/h (13,15 working hours)

DIESEL ENGINE / ENVIRONMENTAL CONDITIONS

Engine make	KUBOTA
Engine type	V-2403-M-DI
Engine system	4 strokes - Inline - Direct Injection
Emissions	Stage III A / Tier 4 Interim
Displacement	2434 cc
N. cylinders	4
Aspiration	Natural
Max engine power @2700 RPM	36,5 kW - 49.0 HP
Max engine speed	2700 RPM
Min engine speed	1600 RPM
Cooling system	Water
Cooling system capacity	8 lt - 1.76 UK gal
Lubrication system	Oil
Lubrication system capacity	9,5 lt - 2.09 UK gal
Max ambient temperature	50°C - 122°F
Max altitude	1800 m a.s.l.
Min working temperature	-10°C / 14°F

Operating pressure	7 bar - 102 psi
Free air delivery	5200 lt/min - 185 cfm
Minimum working pressure	5 bar - 73 psi
Drive system engine-airend	Direct Drive
Compressor cooling system	Air / Oil
Oil cooling capacity	10,7 lt - 2.35 UK gal
Air outlet temperature	40°C - 105°F + Ambient temperature
Outlet valves	2 x 3/4"
Battery capacity	12V cc - 750A-100Ah (EN)
Fuel tank capacity	88 lt - 19.36 UK gal
Consumes	6,7 lt/h - 1.47 UK gal/h (13,15 working hours)

Engine make	KUBOTA
Engine type	V-2403-M-DI
Engine system	4 strokes - Inline - Direct Injection
Emissions	Stage III A / Tier 4 Interim
Displacement	2434 cc
N. cylinders	4
Aspiration	Natural
Max engine power @2700 RPM	36,5 kW - 49.0 HP
Max engine speed	2700 RPM
Min engine speed	1600 RPM
Cooling system	Water
Cooling system capacity	8 lt - 1.76 UK gal
Lubrication system	Oil
Lubrication system capacity	9,5 lt - 2.09 UK gal
Max ambient temperature	50°C - 122°F
Max altitude	1800 m a.s.l.
Min working temperature	-10°C / 14°F

- › Air/oil separator filter, element inside separator tank, can guarantee an excellent air/oil separation.
- › The air and oil filters of the compressor and the air and oil filters of the engine are independent.
- › Spin-on engine and compressor oil filters for faster and easier maintenance.
- › Single stage oversized air filter for compressor part, to guarantee good filtering of the air intake by airend. Two-stage air filter for engine part.
- › Combined radiator allowing both compressor oil cooling and engine liquid cooling.



ROTAIR®



Worldwide
VERSION



*Different features or tech specs may apply
for the European version of this model*

supersilent ›

MDVN

powerful › compact

22K-26K



› | SKID ADAPTOR

- › Design with modern, slender and aggressive line.
- › Electro-galvanized bodywork and chassis with advanced painting procedure to grant an excellent preservation through time.
- › Compact dimensions for easy handling and optimum dimensions/delivered power ratio.
- › Light weight.

- › Filters "spin-on" type for quick maintenance
- › Full accessibility for easy and rapid maintenance and service.
- › European homologation for road circulation with and without brakes.
- › Exclusive pneumatic control system, developed by ROTAIR, to adjust automatically engine revs, depending on the air to be delivered. This system is highly reliable and ensures fuel consumption saving.
- › Air/oil separator filter, highly oversized, can guarantee an excellent air/oil separation.

Technical Data

dimensions >

L = 2841 mm / 111.83"
W = 1400 mm / 55.08"
H = 1230 mm / 48.43"

weight >

480 kg / 1060 lbs (without brakes)
545 kg / 1200 lbs (with brakes)

MDVN 22K

dimensions >

L = 2841 mm / 111.83"
W = 1400 mm / 55.08"
H = 1230 mm / 48.43"

weight >

540 kg / 1190 lbs (without brakes)
605 kg / 1330 lbs (with brakes)

MDVN 26K

COMPRESSOR

(*) = Possibility to have also other operating pressures up to 14/15 bar and Dual Pressure

Operating pressure (*)	6,5 bar 94 psi	10 bar 145 psi	12 bar 174 psi
Free air delivery	2000 l/min 71 cfm	1600 l/min 56 cfm	1400 l/min 50 cfm
Minimum working pressure	5,5 bar - 80 psi		
Drive system engine-arend	Belt Drive		
Compressor cooling system	Air / Oil		
Oil cooling capacity	6 lt - 1.32 UK gal		
Air outlet temperature	40°C - 105°F + Ambient temperature		
Outlet valves	2 x 3/4"		
Noise level EECno 2000/14	< 98 LWA		
Battery capacity	12V cc - 270A-55Ah (EN)		
Fuel tank capacity	30 lt - 6.6 UK gal		
Consumes	3,5 lt/h - 0.77 UK gal/h (8,5 working hours)		

DIESEL ENGINE / ENVIRONMENTAL CONDITIONS

Engine make	KUBOTA
Engine type	D902-E4B
Engine system	4 strokes - Inline
Emissions	Stage V / Tier 4
Displacement	898 cc
N. cylinders	3
Aspiration	Natural
Max engine power @3600 RPM	18,5 kW - 25.0 HP
Max engine speed	3600 RPM
Min engine speed	1900 RPM
Cooling system	Water
Cooling system capacity	4 lt - 0.88 UK gal
Lubrication system	Oil
Lubrication system capacity	4 lt - 0.88 UK gal
Max ambient temperature	50°C - 122°F
Max altitude	1800 m a.s.l.
Min working temperature	-10°C / 14°F

Operating pressure (*)	6,5 bar 94 psi	10 bar 145 psi	12 bar 174 psi
Free air delivery	2500 l/min 88 cfm	1900 l/min 67 cfm	1400 l/min 50 cfm
Minimum working pressure	5,5 bar - 80 psi		
Drive system engine-arend	Belt Drive		
Compressor cooling system	Air / Oil		
Oil cooling capacity	6 lt - 1.32 UK gal		
Air outlet temperature	40°C - 105°F + Ambient temperature		
Outlet valves	2 x 3/4"		
Noise level EECno 2000/14	< 98 LWA		
Battery capacity	12V cc - 270A-55Ah (EN)		
Fuel tank capacity	30 lt - 6.6 UK gal		
Consumes	3,8 lt/h - 0.84 UK gal/h (8 working hours)		

Engine make	KUBOTA
Engine type	D1105-E4B
Engine system	4 strokes - Inline
Emissions	Stage V / Tier 4
Displacement	1123 cc
N. cylinders	3
Aspiration	Natural
Max engine power @3600 RPM	18,5 kW - 25.0 HP
Max engine speed	3000 RPM
Min engine speed	1900 RPM
Cooling system	Water
Cooling system capacity	4 lt - 0.88 UK gal
Lubrication system	Oil
Lubrication system capacity	5,1 lt - 1.12 UK gal
Max ambient temperature	50°C - 122°F
Max altitude	1800 m a.s.l.
Min working temperature	-10°C / 14°F

- › The air and oil filters of the compressor and the air and oil filters of the engine are independent.
- › Single stage oversized air filter for compressor part, to guarantee good filtering of the air intake by airend.
- › Two-stage air filter for engine part.
- › Combined radiator allowing both compressor oil cooling and engine liquid cooling.



ROTAIR®



Worldwide
VERSION



*Different features or tech specs may apply
for the European version of this model*

supersilent >

MDVN

powerful > compact

31K-37K



✔ | SKID ADAPTOR

- › Design with modern, slender and aggressive line.
- › Electro-galvanized bodywork and chassis with advanced painting procedure to grant an excellent preservation through time.
- › Compact dimensions for easy handling and optimum dimensions / delivered power ratio.
- › Light weight.
- › Filters "spin-on" type for quick maintenance.
- › Full accessibility for easy and rapid maintenance and service.
- › European homologation for road circulation with and without brakes.
- › Exclusive pneumatic control system, developed by ROTAIR, to adjust automatically engine revs, depending on the air to be delivered. This system is highly reliable and ensures fuel consumption saving.
- › Start/stop "INTELLIGENT SYSTEM", exclusive from ROTAIR, to prevent the risk of incorrect procedures during specific functioning.

Technical Data

dimensions >

L = 3025 mm / 119.09"

W = 1340 mm / 52.76"

H = 1302 mm / 51.26"

weight >

625kg / 1377 lbs (without brakes)

650 kg / 1433 lbs (with brakes)

MDVN 31K

dimensions >

L = 3025 mm / 119.09"

W = 1340 mm / 52.76"

H = 1302 mm / 51.26"

weight >

625 kg / 1377 lbs (without brakes)

650 kg / 1433 lbs (with brakes)

MDVN 37K

COMPRESSOR

(*) = Possibility to have also other operating pressures up to 14/15 bar and Dual Pressure

Operating pressure (*)	7 bar 102 psi	10 bar 145 psi	12 bar 174 psi
Free air delivery	3000 l/min 106 cfm	2500 l/min 88 cfm	2000 l/min 71 cfm
Minimum working pressure	5 bar - 73 psi		
Drive system engine-airend	Direct Drive		
Compressor cooling system	Air / Oil		
Oil cooling capacity	8,1 lt - 1.78 UK gal		
Air outlet temperature	40°C - 105°F + Ambient temperature		
Outlet valves	2 x 3/4"		
Noise level EECno 2000/14	< 98 LWA		
Battery capacity	12V cc - 680A-74Ah (EN)		
Fuel tank capacity	40 lt - 8.8 UK gal		
Consumes	4,4 lt/h - 0.97 UK gal/h (9 working hours)		

DIESEL ENGINE / ENVIRONMENTAL CONDITIONS

Engine make	KUBOTA
Engine type	V1505-E2B
Engine system	4 strokes - Inline
Emissions	Stage III A / Tier 4 Interim
Displacement	1498 cc
N. cylinders	4
Aspiration	Natural
Max engine power @3000 RPM	26,2 kW - 35.0 HP
Max engine speed	3000 RPM
Min engine speed	1600 RPM
Cooling system	Water
Cooling system capacity	5 lt - 1.1 UK gal
Lubrication system	Oil
Lubrication system capacity	6 lt - 1.32 UK gal
Max ambient temperature	50°C - 122°F
Max altitude	1800 m a.s.l.
Min working temperature	-10°C / 14°F

Operating pressure (*)	7 bar 102 psi	10 bar 145 psi	12 bar 174 psi
Free air delivery	3600 l/min 127 cfm	2900 l/min 102 cfm	2250 l/min 79 cfm
Minimum working pressure	5 bar - 73 psi		
Drive system engine-airend	Direct Drive		
Compressor cooling system	Air / Oil		
Oil cooling capacity	8,1 lt - 1.78 UK gal		
Air outlet temperature	40°C - 105°F + Ambient temperature		
Outlet valves	2 x 3/4"		
Noise level EECno 2000/14	< 98 LWA		
Battery capacity	12V cc - 680A-74Ah (EN)		
Fuel tank capacity	40 lt - 8.8 UK gal		
Consumes	4,9 lt/h - 1.08 UK gal/h (8 working hours)		

Engine make	KUBOTA
Engine type	V1505-E2B
Engine system	4 strokes - Inline
Emissions	Stage III A / Tier 4 Interim
Displacement	1498 cc
N. cylinders	4
Aspiration	Natural
Max engine power @3000 RPM	26,2 kW - 35.0 HP
Max engine speed	3000 RPM
Min engine speed	1600 RPM
Cooling system	Water
Cooling system capacity	5 lt - 1.1 UK gal
Lubrication system	Oil
Lubrication system capacity	6 lt - 1.32 UK gal
Max ambient temperature	50°C - 122°F
Max altitude	1800 m a.s.l.
Min working temperature	-10°C / 14°F

- ▶ Air/oil separator filter, highly oversized, can guarantee an excellent air/oil separation.
- ▶ The air and oil filters of the compressor and the air and oil filters of the engine are independent.
- ▶ Single stage oversized air filter for compressor part, to guarantee good filtering of the air intake by airend.
- ▶ Two-stage air filter for engine part.
- ▶ Combined radiator allowing both compressor oil cooling and engine liquid cooling.



ROTAIR®



supersilent ›

MDVN

powerful › compact

31P-37P



› SKID ADAPTOR

- › Design with modern, slender and aggressive line.
- › Electro-galvanized bodywork and chassis with advanced painting procedure to grant an excellent preservation through time.
- › Compact dimensions for easy handling and optimum dimensions / delivered power ratio.
- › Light weight.
- › Filters "spin-on" type for quick maintenance
- › Full accessibility for easy and rapid maintenance and service.
- › Exclusive pneumatic control system, developed by ROTAIR, to adjust automatically engine revs, depending on the air to be delivered. This system is highly reliable and ensures fuel consumption saving.
- › Start/stop "INTELLIGENT SYSTEM", exclusive from ROTAIR, to prevent the risk of incorrect procedures during specific functioning.
- › Air/oil separator filter, highly oversized, can guarantee an excellent air/oil separation.

Technical Data

dimensions >

L = 3025 mm / 119.09"

W = 1340 mm / 52.76"

H = 1302 mm / 51.26"

weight >

650 kg / 1433 lbs (without brakes)

660 kg / 1455 lbs (with brakes)

MDVN 31P

dimensions >

L = 3025 mm / 119.09"

W = 1340 mm / 52.76"

H = 1302 mm / 51.26"

weight >

650 kg / 1433 lbs (without brakes)

660 kg / 1455 lbs (with brakes)

MDVN 37P

COMPRESSOR

(*) = Possibility to have also other operating pressures up to 14/15 bar and Dual Pressure

Operating pressure (*)	7 bar 102 psi	10 bar 145 psi	12 bar 174 psi
Free air delivery	3000 l/min 106 cfm	2500 l/min 88 cfm	2000 l/min 71 cfm
Minimum working pressure	5 bar - 73 psi		
Drive system engine-airend	Direct Drive		
Compressor cooling system	Air / Oil		
Oil cooling capacity	7 lt - 1.54 UK gal		
Air outlet temperature	40°C - 105°F + Ambient temperature		
Outlet valves	2 x 3/4"		
Noise level EECno 2000/14	< 98 LWA		
Battery capacity	12V cc - 680A-74Ah (EN)		
Fuel tank capacity	40 lt - 8.8 UK gal		
Consumes	4,6 lt/h - 1.01 UK gal/h (8,7 working hours)		

DIESEL ENGINE / ENVIRONMENTAL CONDITIONS

Engine make	PERKINS
Engine type	403D-15
Engine system	4 strokes - Inline
Emissions	Stage III A / Tier 3
Displacement	1496 cc
N. cylinders	3
Aspiration	Natural
Max engine power @3000 RPM	25,1 kW - 34.1 HP
Max engine speed	3000 RPM
Min engine speed	1900 RPM
Cooling system	Water
Cooling system capacity	5 lt - 1.1 UK gal
Lubrication system	Oil
Lubrication system capacity	5 lt - 1.1 UK gal
Max ambient temperature	50°C - 122°F
Max altitude	1800 m a.s.l.
Min working temperature	-10°C / 14°F

Operating pressure (*)	7 bar 102 psi	10 bar 145 psi	12 bar 174 psi
Free air delivery	3600 l/min 127 cfm	2800 l/min 102 cfm	2250 l/min 79 cfm
Minimum working pressure	5 bar - 73 psi		
Drive system engine-airend	Direct Drive		
Compressor cooling system	Air / Oil		
Oil cooling capacity	7 lt - 1.54 UK gal		
Air outlet temperature	40°C - 105°F + Ambient temperature		
Outlet valves	2 x 3/4"		
Noise level EECno 2000/14	< 98 LWA		
Battery capacity	12V cc - 680A-74Ah (EN)		
Fuel tank capacity	40 lt - 8.8 UK gal		
Consumes	4,9 lt/h - 1.08 UK gal/h (8,2 working hours)		

Engine make	PERKINS
Engine type	403D-15
Engine system	4 strokes - Inline
Emissions	Stage III A / Tier 3
Displacement	1496 cc
N. cylinders	3
Aspiration	Natural
Max engine power @3000 RPM	25,1 kW - 34.1 HP
Max engine speed	3000 RPM
Min engine speed	1900 RPM
Cooling system	Water
Cooling system capacity	5 lt - 1.1 UK gal
Lubrication system	Oil
Lubrication system capacity	5 lt - 1.1 UK gal
Max ambient temperature	50°C - 122°F
Max altitude	1800 m a.s.l.
Min working temperature	-10°C / 14°F

- › The air and oil filters of the compressor and the air and oil filters of the engine are independent.
- › Single stage oversized air filter for compressor part, to guarantee good filtering of the air intake by airend.
- › Two-stage air filter for engine part.
- › Combined radiator allowing both compressor oil cooling and engine liquid cooling.



ROTAIR®



Worldwide
VERSION



*Different features or tech specs may apply
for the European version of this model*

supersilent ›

MDVN

powerful › compact

46K-53K



› SKID ADAPTOR

- › Design with modern, slender and aggressive line.
- › Electro-galvanized bodywork and chassis with advanced painting procedure to grant an excellent preservation through time.
- › Compact dimensions for easy handling and optimum dimensions / delivered power ratio.
- › Light weight.
- › Filters “spin-on” type for quick maintenance.
- › Full accessibility for easy and rapid maintenance and service.
- › European homologation for road circulation with and without brakes.
- › Exclusive pneumatic control system, developed by ROTAIR, to adjust automatically engine revs, depending on the air to be delivered. This system is highly reliable and ensures fuel consumption saving.
- › Start/stop “INTELLIGENT SYSTEM”, exclusive from ROTAIR, to prevent the risk of incorrect procedures during specific functioning.

Technical Data

dimensions >

L = 3132 mm / 123.31"
W = 1340 mm / 52.76"
H = 1361 mm / 53.57"

weight >

800 kg / 1765 lbs (without brakes)
856 kg / 1888 lbs (with brakes)

MDVN 46K

dimensions >

L = 3132 mm / 123.31"
W = 1340 mm / 52.76"
H = 1361 mm / 53.57"

weight >

800 kg / 1765 lbs (without brakes)
856 kg / 1888 lbs (with brakes)

MDVN 53K

COMPRESSOR

(*) = Possibility to have also other operating pressures up to 14/15 bar and Dual Pressure

Operating pressure (*)	7 bar 102 psi	10 bar 145 psi	12 bar 174 psi
Free air delivery	4500 l/min 159 cfm	3650 l/min 129 cfm	3400 l/min 120 cfm
Minimum working pressure	5 bar - 73 psi		
Drive system engine-airend	Direct Drive		
Compressor cooling system	Air / Oil		
Oil cooling capacity	10 lt - 2.2 UK gal		
Air outlet temperature	40°C - 105°F + Ambient temperature		
Outlet valves	2 x 3/4" + 1 x 1/1"		
Noise level EECno 2000/14	< 98 LWA		
Battery capacity	12V cc - 680A-74Ah (EN)		
Fuel tank capacity	50 lt - 11 UK gal		
Consumes	6,5 lt/h - 1.43 UK gal/h (8 working hours)		

DIESEL ENGINE / ENVIRONMENTAL CONDITIONS

Engine make	KUBOTA
Engine type	V-2403-M-DI
Engine system	4 strokes - Inline - Direct Injection
Emissions	Stage III A / Tier 4 Interim
Displacement	2434 cc
N. cylinders	4
Aspiration	Natural
Max engine power @3000 RPM	36,5 kW - 49.0 HP
Max engine speed	2700 RPM
Min engine speed	1600 RPM
Cooling system	Water
Cooling system capacity	8 lt - 1.76 UK gal
Lubrication system	Oil
Lubrication system capacity	9,5 lt - 2.09 UK gal
Max ambient temperature	50°C - 122°F
Max altitude	1800 m a.s.l.
Min working temperature	-10°C / 14°F

Operating pressure (*)	7 bar 102 psi	10 bar 145 psi	12 bar 174 psi
Free air delivery	5200 l/min 185 cfm	4150 l/min 147 cfm	3800 l/min 134 cfm
Minimum working pressure	5 bar - 73 psi		
Drive system engine-airend	Direct Drive		
Compressor cooling system	Air / Oil		
Oil cooling capacity	10 lt - 2.2 UK gal		
Air outlet temperature	40°C - 105°F + Ambient temperature		
Outlet valves	2 x 3/4" + 1 x 1/1"		
Noise level EECno 2000/14	< 98 LWA		
Battery capacity	12V cc - 680A-74Ah (EN)		
Fuel tank capacity	50 lt - 11 UK gal		
Consumes	6,7 lt/h - 1.47 UK gal/h (8 working hours)		

Engine make	KUBOTA
Engine type	V-2403-M-DI
Engine system	4 strokes - Inline - Direct Injection
Emissions	Stage III A / Tier 4 Interim
Displacement	2434 cc
N. cylinders	4
Aspiration	Natural
Max engine power @3000 RPM	36,5 kW - 49.0 HP
Max engine speed	2700 RPM
Min engine speed	1600 RPM
Cooling system	Water
Cooling system capacity	8 lt - 1.76 UK gal
Lubrication system	Oil
Lubrication system capacity	9,5 lt - 2.09 UK gal
Max ambient temperature	50°C - 122°F
Max altitude	1800 m a.s.l.
Min working temperature	-10°C / 14°F

- › Air/oil separator filter, highly oversized, can guarantee an excellent air/oil separation.
- › The air and oil filters of the compressor and the air and oil filters of the engine are independent.
- › Single stage oversized air filter for compressor part, to guarantee good filtering of the air intake by airend.
- › Two-stage air filter for engine part.
- › Combined radiator allowing both compressor oil cooling and engine liquid cooling.



ROTAIR®



Worldwide
VERSION

supersilent ›

MDVN

powerful › compact

53 ECO5



NEW!

✂ | **SKID ADAPTOR**

- › Design with modern, slender and aggressive line.
- › Electro-galvanized bodywork and chassis with advanced painting procedure to grant an excellent preservation through time.
- › Compact dimensions for easy handling and optimum dimensions / delivered power ratio.
- › Light weight.
- › Filters "spin-on" type for quick maintenance.
- › Full accessibility for easy and rapid maintenance and service.
- › European homologation for road circulation with and without brakes.
- › Exclusive pneumatic control system, developed by ROTAIR, to adjust automatically engine revs, depending on the air to be delivered. This system is highly reliable and ensures fuel consumption saving.
- › Start/stop "INTELLIGENT SYSTEM", exclusive from ROTAIR, to prevent the risk of incorrect procedures during specific functioning.

Technical Data

dimensions >

L = 3213 mm / 126.5"

W = 1520 mm / 59.8"

H = 1440 mm / 56.7"

weight >

960 kg / 2116 lbs (without brakes)

1020 kg / 2248 lbs (with brakes)

MDVN 53 ECO5

NEW!

COMPRESSOR

Operating pressure	7 bar 102 psi	10 bar 145 psi
Free air delivery	5200 l/min 185 cfm	4150 l/min 147 cfm

DOUBLE FLOW - DOUBLE PRESSURE

Minimum working pressure	5 bar - 73 psi
Drive system engine-airend	Direct Drive
Compressor cooling system	Air / Oil
Oil cooling capacity	10,7 lt - 2.35 UK gal
Air outlet temperature	40°C - 105°F + Ambient temperature
Outlet valves	2 x 3/4"
Noise level EECno 2000/14	< 98 LWA
Battery capacity	12V cc - 750A-100Ah (EN)
Fuel tank capacity	88 lt - 19.36 UK gal
Consumes	6,4 lt/h - 1.41 UK gal/h (8 working hours)

DIESEL ENGINE / ENVIRONMENTAL CONDITIONS

Engine make	KOHLER
Engine type	KDI 1903 TCR St V
Engine system	4 strokes - Inline - Indirect Injection
Emissions	Stage V / Tier 4 Final
Filtration	DOC + DPF
Displacement	1903 cc
N. cylinders	3
Aspiration	Turbocompress
Max engine power @2600 RPM	36,5 kW - 49.0 HP
Max engine speed	2600 RPM
Min engine speed	1700 RPM
Cooling system	Water
Cooling system capacity	14 lt - 3.08 UK gal
Lubrication system	Oil
Lubrication system capacity	9,75 lt - 2.14 UK gal
Max ambient temperature	50°C - 122°F
Max altitude	1800 m a.s.l.
Min working temperature	-10°C / 14°F

...a really BRAND NEW
ECO STAGE V
VERSION

from our

MDVN 53
BEST SALE MODEL



Join To Live
EXPERIENCE

ask for
TRY IT!

- › Air/oil separator filter, highly oversized, can guarantee an excellent air/oil separation.
- › The air and oil filters of the compressor and the air and oil filters of the engine are independent.
- › Single stage oversized air filter for compressor part, to guarantee good filtering of the air intake by airend.
- › Two-stage air filter for engine part.
- › Combined radiator allowing both compressor oil cooling and engine liquid cooling.



ROTAIR®



Worldwide
VERSION

supersilent ›

MDVN

powerful › compact

46P-53P



› SKID ADAPTOR

- › Design with modern, slender and aggressive line.
- › Electro-galvanized bodywork and chassis with advanced painting procedure to grant an excellent preservation through time.
- › Compact dimensions for easy handling and optimum dimensions / delivered power ratio.
- › Light weight.
- › Filters "spin-on" type for quick maintenance.
- › Full accessibility for easy and rapid maintenance and service.
- › Exclusive pneumatic control system, developed by ROTAIR, to adjust automatically engine revs, depending on the air to be delivered. This system is highly reliable and ensures fuel consumption saving.
- › Start/stop "INTELLIGENT SYSTEM", exclusive from ROTAIR, to prevent the risk of incorrect procedures during specific functioning.
- › Air/oil separator filter, highly oversized, can guarantee an excellent air/oil separation.

Technical Data

dimensions >

L = 3132 mm / 123.31"
W = 1340 mm / 52.76"
H = 1361 mm / 53.57"

weight >

850 kg / 1873 lbs (without brakes)
870 kg / 1918 lbs (with brakes)

MDVN 46P

dimensions >

L = 3132 mm / 123.31"
W = 1340 mm / 52.76"
H = 1361 mm / 53.57"

weight >

850 kg / 1873 lbs (without brakes)
870 kg / 1918 lbs (with brakes)

MDVN 53P

COMPRESSOR

(*) = Possibility to have also other operating pressures up to 14/15 bar and Dual Pressure

Operating pressure (*)	7 bar 102 psi	10 bar 145 psi	12 bar 174 psi
Free air delivery	4500 l/min 159 cfm	3800 l/min 134 cfm	3450 l/min 122 cfm
Minimum working pressure	5 bar - 73 psi		
Drive system engine-arend	Direct Drive		
Compressor cooling system	Air / Oil		
Oil cooling capacity	10 lt - 2.2 UK gal		
Air outlet temperature	40°C - 105°F + Ambient temperature		
Outlet valves	2 x 3/4" + 1 x 1"		
Noise level EECno 2000/14	< 98 LWA		
Battery capacity	12V cc - 680A-74Ah (EN)		
Fuel tank capacity	50 lt - 11 UK gal		
Consumes	6,6 lt/h - 1.45 UK gal/h (7,5 working hours)		

DIESEL ENGINE / ENVIRONMENTAL CONDITIONS

Engine make	PERKINS
Engine type	404D-22
Engine system	4 strokes - Inline
Emissions	Stage III A / Tier 2
Displacement	2216 cc
N. cylinders	4
Aspiration	Natural
Max engine power @3000 RPM	37,0 kW - 50.0 HP
Max engine speed	2900 RPM
Min engine speed	1700 RPM
Cooling system	Water
Cooling system capacity	8 lt - 1.76 UK gal
Lubrication system	Oil
Lubrication system capacity	9 lt - 1.98 UK gal
Max ambient temperature	50°C - 122°F
Max altitude	1800 m a.s.l.
Min working temperature	-10°C / 14°F

Operating pressure (*)	7 bar 102 psi	10 bar 145 psi	12 bar 174 psi
Free air delivery	5200 l/min 185 cfm	4400 l/min 155 cfm	4000 l/min 141 cfm
Minimum working pressure	5 bar - 73 psi		
Drive system engine-arend	Direct Drive		
Compressor cooling system	Air / Oil		
Oil cooling capacity	10 lt - 2.2 UK gal		
Air outlet temperature	40°C - 105°F + Ambient temperature		
Outlet valves	2 x 3/4" + 1 x 1"		
Noise level EECno 2000/14	< 98 LWA		
Battery capacity	12V cc - 680A-74Ah (EN)		
Fuel tank capacity	50 lt - 11 UK gal		
Consumes	7,2 lt/h - 1.58 UK gal/h (6,9 working hours)		

Engine make	PERKINS
Engine type	404D-22
Engine system	4 strokes - Inline
Emissions	Stage III A / Tier 2
Displacement	2216 cc
N. cylinders	4
Aspiration	Natural
Max engine power @3000 RPM	37,0 kW - 50.0 HP
Max engine speed	2900 RPM
Min engine speed	1700 RPM
Cooling system	Water
Cooling system capacity	8 lt - 1.76 UK gal
Lubrication system	Oil
Lubrication system capacity	9 lt - 1.98 UK gal
Max ambient temperature	50°C - 122°F
Max altitude	1800 m a.s.l.
Min working temperature	-10°C / 14°F

- > The air and oil filters of the compressor and the air and oil filters of the engine are independent.
- > Single stage oversized air filter for compressor part, to guarantee good filtering of the air intake by arend.
- > Two-stage air filter for engine part.
- > Combined radiator allowing both compressor oil cooling and engine liquid cooling.



ROTAIR®



Worldwide
VERSION

supersilent ›

MDVN

powerful › compact

54Y



› | **SKID ADAPTOR**

› Electro-galvanized bodywork and chassis with advanced painting procedure to grant an excellent preservation through time.

- › Full accessibility for easy and rapid maintenance and service.
- › Exclusive pneumatic control system, developed by ROTAIR, to adjust automatically engine revs, depending on the air to be delivered. This system is highly reliable and ensures fuel consumption saving.
- › Start/stop "INTELLIGENT SYSTEM", exclusive from ROTAIR, to prevent the risk of incorrect procedures during specific functioning.

Technical Data

dimensions >

L = 3264 mm / 10' 7"

W = 1528 mm / 5' 0"

H = 1470 mm / 4' 8"

weight >

950 kg / 2094 lbs (without brakes)

MDVN 54Y

NEW!

COMPRESSOR

Operating pressure	7 bar 102 psi
Free air delivery	5400 l/min 190 cfm
Drive system engine-airend	Direct Drive
Compressor cooling system	Air / Oil
Oil cooling capacity	10 lt - 2.2 UK gal
Air outlet temperature	40°C - 105°F + Ambient temperature
Outlet valves	2 x 1"
Battery capacity	12V cc - 750A-100Ah (EN)
Fuel tank capacity	54 lt - 11.88 UK gal
Consumes	6,6 lt/h - 1.45 UK gal/h (7,5 working hours)

DIESEL ENGINE / ENVIRONMENTAL CONDITIONS

Engine make	YANMAR
Engine type	4TNV 88-DSAP
Engine system	4 strokes - Inline
Emissions	Stage III A / Tier 2
Displacement	2190 cc
N. cylinders	4
Aspiration	Natural
Max engine power @2600 RPM	35 kW - 46.9 HP
Max engine speed	3000 RPM
Min engine speed	1500 RPM
Cooling system	Water
Cooling system capacity	8 lt - 1.76 UK gal (glicole 50%)
Lubrication system	Oil
Lubrication system capacity	7 lt - 1.54 UK gal
Max ambient temperature	50°C - 122°F
Max altitude	1800 m a.s.l.
Min working temperature	-10°C / 14°F



**NEW
MODEL
YANMAR
ENGINE**

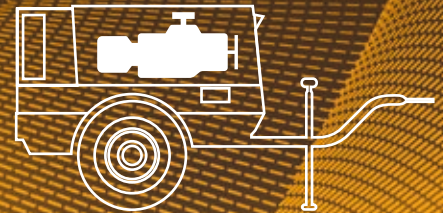

Join To Live
EXPERIENCE

ROTAIR®



Worldwide
VERSION

supersilent ›

MDVN

powerful › compact

72Y



› SKID ADAPTOR

- › Design with modern, slender and aggressive line.
- › Electro-galvanized bodywork and chassis with advanced painting procedure to grant an excellent preservation through time.
- › Compact dimensions for easy handling and optimum dimensions / delivered power ratio.
- › Light weight.

- › Filters "spin-on" type for quick maintenance.
- › Full accessibility for easy and rapid maintenance and service.
- › Exclusive pneumatic control system, developed by ROTAIR, to adjust automatically engine revs, depending on the air to be delivered. This system is highly reliable and ensures fuel consumption saving.
- › Start/stop "INTELLIGENT SYSTEM", exclusive from ROTAIR, to prevent the risk of incorrect procedures during specific functioning.
- › Air/oil separator filter, highly oversized, can guarantee an excellent air/oil separation.

Technical Data

dimensions ›

L = 3491 mm / 137.45"

W = 1580 mm / 62.20"

H = 1680 mm / 66.14"

weight ›

1240 kg / 2734 lbs (without brakes)

MDVN 72Y

NEW!

COMPRESSOR

Operating pressure (*)	7 bar 102 psi	10 bar 145 psi	12 bar 174 psi
Free air delivery	7100 l/min 250 cfm	6400 l/min 226 cfm	4600 l/min 162 cfm
Minimum working pressure	5,5 bar - 80 psi		
Drive system engine-arend	Direct Drive		
Compressor cooling system	Air / Oil		
Outlet valves	2 x 3/4" + 1 x 1"		
Battery capacity	12V cc - 750A-100Ah (EN)		
Fuel tank capacity	92 lt - 20.24 UK gal		
Consumes	8,44 lt/h - 1.86 UK gal/h (10,9 working hours)		

DIESEL ENGINE / ENVIRONMENTAL CONDITIONS

Engine make	YANMAR
Engine type	4TNV 98-hsap
Engine system	4 strokes - Inline - Direct Injection
Emissions	Stage II / Tier 2
Displacement	3519 cc
N. cylinders	4
Aspiration	Natural
Max engine power @2500 RPM	50,7 kW - 68.9 HP
Max engine speed	2500 RPM
Min engine speed	1500 RPM
Cooling system	Water
Cooling system capacity	12 lt - 2.64 UK gal
Lubrication system	Oil
Max ambient temperature	50°C - 122°F
Max altitude	1800 m a.s.l.
Min working temperature	-10°C / 14°F



**NEW
MODEL
YANMAR
ENGINE**

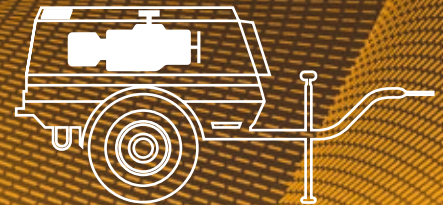

Join To Live
EXPERIENCE

- › The air and oil filters of the compressor and the air and oil filters of the engine are independent.
- › Two stages oversized air filter for compressor part, to guarantee good filtering of the air intake by airend.
- › Two-stage air filter for engine part.
- › Combined radiator allowing both compressor oil cooling and engine liquid cooling.



ROTAIR®



Worldwide
VERSION

supersilent ›

MDVN

powerful › compact

80Y



› | SKID ADAPTOR

- › Design with modern, slender and aggressive line.
- › Electro-galvanized bodywork and chassis with advanced painting procedure to grant an excellent preservation through time.
- › Compact dimensions for easy handling and optimum dimensions / delivered power ratio.
- › Light weight.

- › Filters "spin-on" type for quick maintenance.
- › Full accessibility for easy and rapid maintenance and service.
- › Exclusive pneumatic control system, developed by ROTAIR, to adjust automatically engine revs, depending on the air to be delivered. This system is highly reliable and ensures fuel consumption saving.
- › Start/stop "INTELLIGENT SYSTEM", exclusive from ROTAIR, to prevent the risk of incorrect procedures during specific functioning.
- › Air/oil separator filter, highly oversized, can guarantee an excellent air/oil separation.

Technical Data

dimensions ›

L = 3491 mm / 137.45"

W = 1580 mm / 62.20"

H = 1680 mm / 66.14"

weight ›

1240 kg / 2734 lbs (without brakes)

MDVN 80Y

NEW!

COMPRESSOR

Operating pressure (*)	7 bar 102 psi	10 bar 145 psi	12 bar 174 psi
Free air delivery	7800 l/min 275 cfm	6800 l/min 240 cfm	4900 l/min 173 cfm
Minimum working pressure	5,5 bar - 80 psi		
Drive system engine-arend	Direct Drive		
Compressor cooling system	Air / Oil		
Outlet valves	2 x 3/4" + 1 x 1"		
Battery capacity	12V cc - 750A-100Ah (EN)		
Fuel tank capacity	92 lt - 20.24 UK gal		
Consumes	8,9 lt/h - 1.96 UK gal/h (10,3 working hours)		

DIESEL ENGINE / ENVIRONMENTAL CONDITIONS

Engine make	YANMAR
Engine type	4TNV 98-hsap
Engine system	4 strokes - Inline - Direct Injection
Emissions	Stage II / Tier 2
Displacement	3519 cc
N. cylinders	4
Aspiration	Natural
Max engine power @2500 RPM	50,7 kW - 68.9 HP
Max engine speed	2500 RPM
Min engine speed	1500 RPM
Cooling system	Water
Cooling system capacity	12 lt - 2.64 UK gal
Lubrication system	Oil
Max ambient temperature	50°C - 122°F
Max altitude	1800 m a.s.l.
Min working temperature	-10°C / 14°F



**NEW
MODEL
YANMAR
ENGINE**

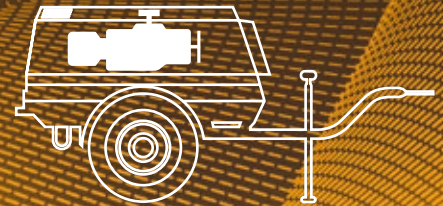

Join To Live
EXPERIENCE

- › The air and oil filters of the compressor and the air and oil filters of the engine are independent.
- › Two stages oversized air filter for compressor part, to guarantee good filtering of the air intake by arend.
- › Two-stage air filter for engine part.
- › Combined radiator allowing both compressor oil cooling and engine liquid cooling.



ROTAIR®



Worldwide
VERSION



*Different features or tech specs may apply
for the European version of this model*

supersilent ›

MDVN

powerful › compact

82KH



› SKID ADAPTOR

- › Design with modern, slender and aggressive line.
- › Electro-galvanized bodywork and chassis with advanced painting procedure to grant an excellent preservation through time.
- › Compact dimensions for easy handling and optimum dimensions / delivered power ratio.
- › Filters "spin-on" type for quick maintenance.

- › KOHLER Stage IV-Tier Final compliant, without DPF filtration system (less maintenance costs)
- › Full accessibility for easy and rapid maintenance and service.
- › European homologation for road circulation with brakes.
- › Exclusive pneumatic control system, developed by ROTAIR, to adjust automatically engine revs, depending on the air to be delivered. This system is highly reliable and ensures fuel consumption saving.
- › Start/stop "INTELLIGENT SYSTEM", exclusive from ROTAIR, to prevent the risk of incorrect procedures during specific functioning.

Technical Data

dimensions >

L = 3491 mm / 137.44"

W = 1580 mm / 62.2"

H = 1682 mm / 66.23"

weight >

1386 kg / 3055 lbs (without brakes)

1540 kg / 3395 lbs (with brakes)

MDVN 82KH

DO YOU
KNOW



COMPRESSOR

(*) = Possibility to have also other operating pressures up to 14/15 bar and Dual Pressure

Operating pressure (*)	7 bar 102 psi	10 bar 145 psi	12 bar 174 psi
Free air delivery	8000 l/min 282 cfm	6400 l/min 226 cfm	5600 l/min 198 cfm
Minimum working pressure	5,5 bar - 80 psi		
Drive system engine-arend	Direct Drive		
Compressor cooling system	Air / Oil		
Oil cooling capacity	16 lt - 3.52 UK gal		
Air outlet temperature	40°C - 105°F + Ambient temperature		
Outlet valves	2 x 3/4" + 1 x 1"		
Noise level EECno 2000/14	< 98 LWA		
Battery capacity	12V cc - 950A-132Ah (EN)		
Fuel tank capacity	92 lt - 20.24 UK gal		
Consumes	9,3 lt/h - 2.05 UK gal/h (9,9 working hours)		

DIESEL ENGINE / ENVIRONMENTAL CONDITIONS

Engine make	KOHLER
Engine type	KDI2504-TCR
Engine system	4 strokes - Inline - Direct Injection
Emissions	Stage III B / Tier 4 Final
Filtration	DOC
Displacement	2482 cc
N. cylinders	4
Aspiration	Turbo Intercooler
Max engine power @2600 RPM	55,4 kW - 73.6 HP
Max engine speed	2100 RPM
Min engine speed	1700 RPM
Cooling system	Water
Cooling system capacity	17 lt - 3.74 UK gal
Lubrication system	Oil
Lubrication system capacity	10 lt - 2.2 UK gal
Max ambient temperature	50°C - 122°F
Max altitude	1800 m a.s.l.
Min working temperature	-10°C / 14°F

...all our
ranges

also
available
AS...

customized
**SANDBLASTING
VERSION**

**INBUILT ADDITIONAL COOLER AND
SPECIFIC CONDENSATE SEPARATOR**

for cool and dry air

Air/oil separator filter, highly oversized, can guarantee an
› excellent air/oil separation.

The air and oil filters of the compressor and the air and oil filters of
› the engine are independent.

Two stages oversized air filter for compressor part,
› to guarantee good filtering of the air intake by airend.

› Two-stage air filter for engine part.

Combined radiator allowing both compressor oil cooling and
engine liquid cooling.



ROTAIR®



Worldwide
VERSION

supersilent ›

MDVS

powerful › compact

120J-120P



› | SKID ADAPTOR

- › Design with modern, slender and aggressive line.
- › Electro-galvanized bodywork and chassis with advanced painting procedure to grant an excellent preservation through time.
- › Compact dimensions for easy handling and optimum dimensions / delivered power ratio.
- › Light weight for the compressor class.
- › Filters "spin-on" type for quick maintenance.
- › Full accessibility for easy and rapid maintenance and service.
- › Exclusive pneumatic control system, developed by ROTAIR, to adjust automatically engine revs, depending on the air to be delivered. This system is highly reliable and ensures fuel consumption saving.
- › Start/stop "INTELLIGENT SYSTEM", exclusive from ROTAIR, to prevent the risk of incorrect procedures during specific functioning.
- › Air/oil separator filter, highly oversized, can guarantee an excellent air/oil separation.

Technical Data

dimensions >

L = 4524 mm / 178.12"

W = 1975 mm / 77.76"

H = 2191 mm / 86.26"

weight >

1920 kg / 4233 lbs (without brakes)

2020 kg / 4453 lbs (with brakes)

MDVS 120J

dimensions >

L = 4524 mm / 178.12"

W = 1975 mm / 77.76"

H = 2191 mm / 86.26"

weight >

1920 kg / 4233 lbs (without brakes)

2020 kg / 4453 lbs (with brakes)

MDVS 120P

COMPRESSOR

(*) = Possibility to have also other operating pressures up to 14/15 bar and Dual Pressure

Operating pressure (*)	7 bar 102 psi	10 bar 145 psi	12 bar 174 psi
Free air delivery	12000 l/min 424 cfm	11000 l/min 388 cfm	10000 l/min 353 cfm
Minimum working pressure	5,5 bar - 80 psi		
Drive system engine-airend	Direct Drive		
Compressor cooling system	Air / Oil		
Oil cooling capacity	29 lt - 6.38 UK gal		
Air outlet temperature	40°C - 105°F + Ambient temperature		
Outlet valves	3 x 3/4" + 1 x 2"		
Noise level EECno 2000/14	> 99 LWA		
Battery capacity	12V cc - 950A-132Ah (EN)		
Fuel tank capacity	150 lt - 33 UK gal		
Consumes	14,9 lt/h - 3.28 UK gal/h (10 working hours)		

DIESEL ENGINE / ENVIRONMENTAL CONDITIONS

Engine make	JCB
Engine type	444 - TCA
Engine system	4 strokes - Inline
Emissions	Stage II / Tier 2
Displacement	4400 cc
N. cylinders	4
Aspiration	Turbo Intercooler
Max engine power @2200 RPM	93 kW - 126 HP
Max engine speed	2200 RPM
Min engine speed	1600 RPM
Cooling system	Water
Cooling system capacity	22 lt - 4.84 UK gal
Lubrication system	Oil
Lubrication system capacity	14 lt - 3.08 UK gal
Max ambient temperature	50°C - 122°F
Max altitude	1800 m a.s.l.
Min working temperature	-10°C / 14°F

Operating pressure (*)	7 bar 102 psi	10 bar 145 psi	12 bar 174 psi
Free air delivery	12000 l/min 424 cfm	10500 l/min 370 cfm	9500 l/min 335 cfm
Minimum working pressure	5,5 bar - 80 psi		
Drive system engine-airend	Direct Drive		
Compressor cooling system	Air / Oil		
Oil cooling capacity	29 lt - 6.38 UK gal		
Air outlet temperature	40°C - 105°F + Ambient temperature		
Outlet valves	3 x 3/4" + 1 x 2"		
Noise level EECno 2000/14	> 99 LWA		
Battery capacity	12V cc - 950A-132Ah (EN)		
Fuel tank capacity	150 lt - 33 UK gal		
Consumes	15,2 lt/h - 3.34 UK gal/h (9,9 working hours)		

Engine make	PERKINS
Engine type	1104C-44TA
Engine system	4 strokes - Inline
Emissions	Stage II / Tier 2
Displacement	4400 cc
N. cylinders	4
Aspiration	Turbo Intercooler
Max engine power @2200 RPM	97 kW - 132 HP
Max engine speed	2200 RPM
Min engine speed	1600 RPM
Cooling system	Water
Cooling system capacity	25 lt - 5.5 UK gal
Lubrication system	Oil
Lubrication system capacity	8 lt - 1.76 UK gal
Max ambient temperature	50°C - 122°F
Max altitude	1800 m a.s.l.
Min working temperature	-10°C / 14°F

- › The air and oil filters of the compressor and the air and oil filters of the engine are independent.
- › Single stage oversized air filter for compressor part, to guarantee good filtering of the air intake by airend. As option, two-stage air filter for engine part.
- › Fuel pre-filter with water separation and second filter to clean fuel in very dusty conditions.
- › Combined radiator allowing both compressor oil cooling and engine liquid cooling.



ROTAIR®



Worldwide
VERSION



*Different features or tech specs may apply
for the European version of this model*

supersilent ›

MDVS

powerful › compact

125C



› SKID ADAPTOR

- › Design with modern, slender and aggressive line.
- › Electro-galvanized bodywork and chassis with advanced painting procedure to grant an excellent preservation through time.
- › Compact dimensions for easy handling and optimum dimensions / delivered power ratio.
- › Light weight for the compressor class.

- › Filters "spin-on" type for quick maintenance.
- › Full accessibility for easy and rapid maintenance and service.
- › Exclusive pneumatic control system, developed by ROTAIR, to adjust automatically engine revs, depending on the air to be delivered. This system is highly reliable and ensures fuel consumption saving.
- › Start/stop "INTELLIGENT SYSTEM", exclusive from ROTAIR, to prevent the risk of incorrect procedures during specific functioning.
- › Air/oil separator filter, highly oversized, can guarantee an excellent air/oil separation.

Technical Data

dimensions >

L = 3957 mm / 155.79"

W = 1890 mm / 74.41"

H = 1840 mm / 72.44"

weight >

1970 kg / 4343 lbs (without brakes)

2245 kg / 4949 lbs (with brakes)

MDVS 125C

NEW TYPE

COMPRESSOR (*) = Possibility to have also other operating pressures up to 14/15 bar and Dual Pressure

Operating pressure (*)	7 bar 102 psi	10 bar 145 psi	12 bar 174 psi
Free air delivery	12000 l/min 424 cfm	11000 l/min 388 cfm	10000 l/min 353 cfm

DUAL PRESSURE

Minimum working pressure	5,5 bar - 80 psi
Drive system engine-airend	Direct Drive
Compressor cooling system	Air / Oil
Oil cooling capacity	29,5 lt - 6.49 UK gal
Air outlet temperature	40°C - 105°F + Ambient temperature
Outlet valves	3 x 3/4" + 1 x 2"
Noise level EECno 2000/14	< 99 LWA
Battery capacity	2 x 12V cc - 680A-74Ah (EN)
Fuel tank capacity	200 lt - 43.99 UK gal
Consumes	15,4 lt/h - 3.39 UK gal/h (11,2 working hours)

DIESEL ENGINE / ENVIRONMENTAL CONDITIONS

Engine make	CUMMINS
Engine type	QSF 3.8
Engine system	4 strokes - In-line
Emissions	Stage IV / Tier 4 Final
Filtration	DOC + SCR
Displacement	3800 cc
N. cylinders	4
Aspiration	Turbo Intercooler
Max engine power @3000 RPM	97 kW - 130 HP
Max engine speed	2200 RPM
Min engine speed	1200 RPM
Cooling system	Water
Cooling system capacity	24 lt - 5.28 UK gal
Lubrication system	Oil
Lubrication system capacity	15,6 lt - 3.43 UK gal
Max ambient temperature	50°C - 122°F
Max altitude	1800 m a.s.l.
Min working temperature	-10°C / 14°F

NEW ENGINE



Join To Live
EXPERIENCE

ask for
TRY IT!

- › The air and oil filters of the compressor and the air and oil filters of the engine are independent.
- › Single stage oversized air filter for compressor part, to guarantee good filtering of the air intake by airend. As option, two-stage air filter for engine part.
- › Fuel pre-filter with water separation and second filter to clean fuel in very dusty conditions.
- › Combined radiator allowing both compressor oil cooling and engine liquid cooling.



ROTAIR®



Worldwide
VERSION

supersilent ›

MDVS

powerful › compact

170J



› | SKID ADAPTOR

- › Design with modern, slender and aggressive line.
- › Electro-galvanized bodywork and chassis with advanced painting procedure to grant an excellent preservation through time.
- › Compact dimensions for easy handling and optimum dimensions / delivered power ratio.
- › Light weight for the compressor class.
- › Filters "spin-on" type for quick maintenance.
- › Full accessibility for easy and rapid maintenance and service.
- › Exclusive pneumatic control system, developed by ROTAIR, to adjust automatically engine revs, depending on the air to be delivered. This system is highly reliable and ensures fuel consumption saving.
- › Start/stop "INTELLIGENT SYSTEM", exclusive from ROTAIR, to prevent the risk of incorrect procedures during specific functioning.
- › Air/oil separator filter, highly oversized, can guarantee an excellent air/oil separation.

Technical Data

dimensions

L = 4524 mm / 178.12"

W = 1975 mm / 77.76"

H = 2191 mm / 86.26"

weight

2200 kg / 4850 lbs

MDVS 170J

COMPRESSOR

Operating pressure	7 bar 102 psi	10 bar 145 psi	12 bar 174 psi	14 bar 203 psi	15 bar 218 psi
Free air delivery	17000 lt/min 600 cfm	15000 lt/min 530 cfm	13400 lt/min 474 cfm	12000 lt/min 423 cfm	11100 m ³ /min 388 cfm
Minimum working pressure	5,5 bar - 80 psi				
Drive system engine-airend	Direct Drive				
Compressor cooling system	Air / Oil				
Oil cooling capacity	39,5 lt - 8.69 UK gal				
Air outlet temperature	40°C - 105°F + Ambient temperature				
Outlet valves	3 x 3/4" + 1 x 2"				
Noise level EECno 2000/14	> 99 LWA				
Battery capacity	12V cc - 950A-132Ah (EN)				
Fuel tank capacity	150 lt - 33 UK gal				
Consumes	20 lt/h - 4.4 UK gal/h (7,5 working hours)				

Diesel Engine / Environmental Conditions

Engine make	JCB
Engine type	TCAE-120KW
Engine system	4 strokes - In-line - Direct Injection
Emissions	Stage III A / Tier 3
Displacement	4400 cc
N. cylinders	4
Aspiration	Turbo Intercooler
Max engine power @3000 RPM	120 kW - 162 HP
Max engine speed	2200 RPM
Min engine speed	1600 RPM
Cooling system	Water
Cooling system capacity	22 lt - 4.84 UK gal
Lubrication system	Oil
Lubrication system capacity	14 lt - 3.08 UK gal
Max ambient temperature	50°C - 122°F
Max altitude	1800 m a.s.l.
Min working temperature	-10°C / 14°F

- › The air and oil filters of the compressor and the air and oil filters of the engine are independent.
- › Single stage oversized air filter for compressor part, to guarantee good filtering of the air intake by airend. As option, two-stage air filter for engine part.
- › Fuel pre-filter with water separation and second filter to clean fuel in very dusty conditions.
- › Combined radiator allowing both compressor oil cooling and engine liquid cooling.



supersilent >

MDVS

powerful > compact

255C-255D



✔ | SKID ADAPTOR

- › Design with modern, practical line.
- › Electro-galvanized bodywork and chassis with advanced painting procedure to grant an excellent preservation through time.
- › Sizing for easy handling and optimum dimensions / delivered power ratio.
- › Oil filter "spin-on" type for quick maintenance.
- › Full accessibility for easy and rapid maintenance and service.
- › Exclusive pneumatic control system, developed by ROTAIR, to adjust automatically engine revs, depending on the air to be delivered. This system is highly reliable and ensures fuel consumption saving.
- › Start/stop "INTELLIGENT SYSTEM", exclusive from ROTAIR, to prevent the risk of incorrect procedures during specific functioning.
- › Air/oil separator filter, highly oversized, can guarantee an excellent air/oil separation.

Technical Data

dimensions >

L = 6142 mm / 241.83"

W = 1960 mm / 77.17"

H = 2220 mm / 87.4"

weight >

3200 kg / 7065 lbs (without brakes)

3250 kg / 7165 lbs (with brakes)

MDVS 255C

dimensions >

L = 6142 mm / 241.83"

W = 1960 mm / 77.17"

H = 2220 mm / 87.40"

weight >

3300 kg / 7275 lbs (without brakes)

3350 kg / 7385 lbs (with brakes)

MDVS 255D

COMPRESSOR

(*) = Possibility to have also other operating pressures up to 14/15 bar and Dual Pressure

Operating pressure (*)	8 bar 116 psi	10 bar 145 psi	12 bar 174 psi
Free air delivery	25,3 m ³ /min 893 cfm	22,7 m ³ /min 802 cfm	20,5 m ³ /min 723 cfm
Minimum working pressure	5,5 bar - 80 psi		
Drive system engine-airend	Direct Drive		
Compressor cooling system	Air / Oil		
Oil cooling capacity	62,5 lt - 13.75 UK gal		
Air outlet temperature	40°C - 105°F + Ambient temperature		
Outlet valves	3 x 3/4" + 1 x 2"		
Noise level EECno 2000/14	> 100 LWA		
Battery capacity	12V cc - 750A-100Ah (EN)		
Fuel tank capacity	380 lt - 83.59 UK gal		
Consumes	32,9 lt/h - 7.24 UK gal/h (11,5 working hours)		

DIESEL ENGINE / ENVIRONMENTAL CONDITIONS

Engine make	CUMMINS
Engine type	QSB6.7
Engine system	4 strokes - Inline
Emissions	Stage III A / Tier 3
Displacement	6700 cc
N. cylinders	6
Aspiration	Turbo Intercooler
Max engine power	194 kW - 262 HP (@ 2200 RPM)
Max engine speed	2200 RPM
Min engine speed	1400 RPM
Cooling system	Water
Cooling system capacity	33 lt - 7.26 UK gal
Lubrication system	Oil
Lubrication system capacity	14 lt - 3.08 UK gal
Max ambient temperature	50°C - 122°F
Max altitude	1800 m a.s.l.
Min working temperature	-10°C / 14°F

Operating pressure (*)	8 bar 116 psi	10 bar 145 psi	12 bar 174 psi
Free air delivery	25,3 m ³ /min 893 cfm	22,7 m ³ /min 802 cfm	18 m ³ /min 636 cfm
Minimum working pressure	5,5 bar - 80 psi		
Drive system engine-airend	Direct Drive		
Compressor cooling system	Air / Oil		
Oil cooling capacity	62,5 lt - 13.75 UK gal		
Air outlet temperature	40°C - 105°F + Ambient temperature		
Outlet valves	3 x 3/4" + 1 x 2"		
Noise level EECno 2000/14	> 100 LWA		
Battery capacity	12V cc - 750A-100Ah (EN)		
Fuel tank capacity	380 lt - 83.59 UK gal		
Consumes	31,9 lt/h - 7.02 UK gal/h (11,9 working hours)		

Engine make	DEUTZ
Engine type	BF6M 1013FC
Engine system	4 strokes - Inline
Emissions	Stage II / Tier 2
Displacement	7100 cc
N. cylinders	6
Aspiration	Turbo Intercooler
Max engine power	190 kW - 257 HP (@ 2300 RPM)
Max engine speed	2300 RPM
Min engine speed	1300 RPM
Cooling system	Water
Cooling system capacity	34 lt - 7.48 UK gal
Lubrication system	Oil
Lubrication system capacity	14,5 lt - 3.19 UK gal
Max ambient temperature	50°C - 122°F
Max altitude	1800 m a.s.l.
Min working temperature	-10°C / 14°F

- > The air and oil filters of the compressor and the air and oil filters of the engine are independent.
- > Single stage oversized air filter for compressor part, to guarantee good filtering of the air intake by airend. As option, two-stage air filter for engine part.
- > Fuel pre-filter with water separation and second filter to clean fuel in very dusty conditions.
- > Combined radiator allowing both compressor oil cooling and engine liquid cooling.



ROTAIR®



Worldwide
VERSION



*Different features or tech specs may apply
for the European version of this model*

supersilent ›

VRK

powerful › compact

215 FIBRA FIBRA^{PLUS}



**FROM MOTORWAYS TO DIGITAL
HIGHWAYS, COMPRESSED AIR HAS
ALWAYS PLAYED A LEADING ROLE
IN BUILDING THE NEXT FUTURE**

**COMPACT DESIGN, EXTREMELY
MANEUVERABLE AND EASY
ACCESS FOR MAINTENANCE.
ALL FILTERS READILY ACCESSIBLE.**

**ONE SINGLE, COMPACT,
EASY TO TRANSPORT AND
MANEUVERABLE MACHINE,
IMMEDIATELY READY TO WORK.**

- › All moving parts are inaccessible, according to the most stringent safety norms.
- › Cooling ventilator shielded and inaccessible.
- › Muffler under the machine, less noise and avoids risks of accidental burns.
- › Cooling fan on the engine axle.
- › Easy to lift & transport.
- › Lifting eye for crane use / Solid-type wheels / Skid version available on option
- › Double-stage air/oil separation
Lowest oil in air for this category: ≤ 1 PPM!
- › Air cooling and drying integrated in the unit.

- › System for proportional acceleration at air demand:
 - ›› Less noise and consumption / ›› Power all declinated to air flow
- › Petrol tank in sight & extractable for practical refuelling
- › All filters are spin-on / bayonet-type, for faster change
- › Intuitive starter / Integrated hours counter / Manometer / Thermostat with safety arrest @ high temperatures
- › Start/Stop @ low pressures:
 - ›› Automatically activated when starting the machine
 - ›› Brings machine to 2 bar
 - ›› Prevents separator filter to collapse due to difference pressure
 - ›› Longer life of machine and components
 - ›› Avoids oil in line
 - ›› Better start in cold temperatures.
- › Oversized single cooler for extra cooling of air.
- › Condensates separator / Compressed air temperature: Ambient +20°C / 68°F

dimensions >

L = 1190 mm / 46.85"

W = 770 mm / 30.31"

H = 956 mm / 37.64"

weight >

220 kg / 485 lbs

VRK 215 FIBRA FIBRA^{PLUS}

INTEGRATED COOLING AND DRYING SYSTEMS

SPECIAL FIBRE OPTIC

CONCEIVED FOR
FIBRE-OPTIC
CABLE LAYING



COMPRESSOR

Max operation pressure	15 bar - 218 psi
Free Air Delivery	1000 l/min - 28 cfm
Minimum working pressure	5,5 bar - 80 psi
Drive system engine-airend	Belt-drive XPZ overdimensioned
Compressor cooling system	Air / Oil
Oil cooling capacity	5 lt - 1.1 UK gal
Outlet valves	1 x 3/4"
Noise level EECno 2000/14	< 97 LWA
Battery capacity	12V cc - 300A-30Ah (EN)
Fuel tank capacity	15 lt - 3.3 UK gal

PETROL ENGINE

Engine make	HONDA
Engine type	GX690
Engine system	4 strokes
Emissions	Stage V
Displacement	690 cc
N. cylinders	2
Aspiration	Natural
Max engine power @3600 RPM	16.5 kW - 22.5 HP
Max engine speed	3400 RPM
Min engine speed	2000 RPM
Cooling system	Air
Lubrication system	Oil
Lubrication system capacity	1,9 lt - 0.42 UK gal

QUALITY OF AIR

Oil in air	≤ 1 PPM
Compressed air temperature	Ambient +20°C +68°F (FIBRA) Ambient +0°C/+2°C +32°F/+35,6°F (FIBRA PLUS)

ENVIRONMENTAL CONDITIONS

Max altitude	1800 m a.s.l.
Min / Max working temperature	-10°C / +50°C 14°F / 122°F

- › Encapsulated airend with ROTAIR design profile, max efficiency and operational safety.
- › High efficiency trapezoidal belt-drive, over-dimensioned to ensure transmission with less maintenance.
- › Pneumatic control system, ROTAIR production, to automatically adjust engine revs, depending on the air to be delivered. This system is highly reliable and ensures fuel consumption savings.
- › Automatic depressurization at the end of the work cycle.
- › Encapsulated separator tank with double separation-internal filter and external spin-on: oil carry-over ≤ 1 PPM.
- › Air/oil separator filter, highly oversized, to guarantee an excellent air/oil separation.
- › Compressor air filter and engine air filter are separated.
- › Single stage oversized air filter for compression circuit, to guarantee good filtering of the air intaken by airend.

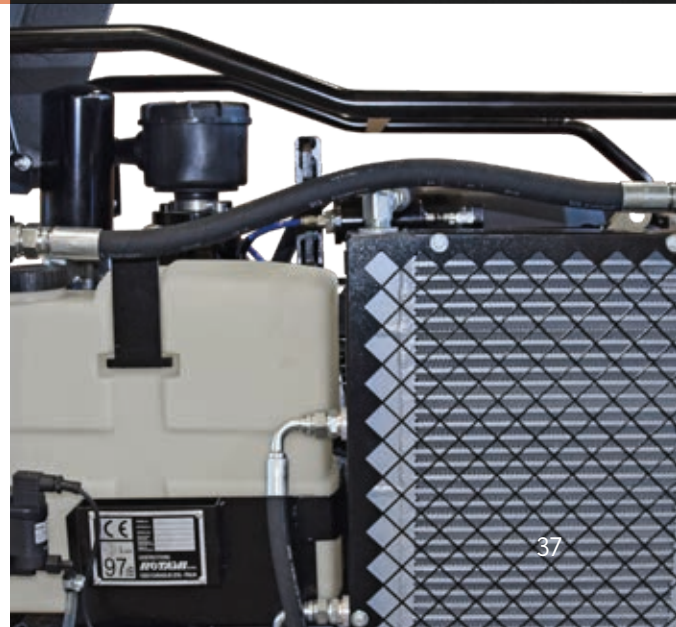

supersilent ›

VRK

powerful › compact

16 ›› 22



COMPRESSOR

Working pressure

Working pressure

Minimum working pressure

Drive system engine-arend

Compressor cooling system

Oil cooling capacity

Air outlet temperature

Outlet valves

Noise level EECno 2000/14

Battery capacity

Fuel tank capacity

PETROL ENGINE

Engine make

Engine type

Engine system

Emissions

Displacement

N. cylinders

Aspiration

Max engine power @3600 RPM

Max engine speed

Min engine speed

Cooling system

Lubrication system

Lubrication system capacity

Min › Max working temperature

Max Altitude

- › Compact design, extremely maneuverable and easy access for maintenance.
- › All filters readily accessible.
- › All filters (except air filter) are spin-on type, for easier maintenance.
- › All moving parts are inaccessible, according to the most stringent safety norms.
- › Easy to transport and to load.
- › Lifting eye for crane use.

- › Muffler under the machine, less noise and avoids risks of accidental burns.
- › Cooling ventilator shielded and inaccessible.
- › Cooling fan on the engine axle.
- › Intuitive starter / Integrated hours counter / Manometer.
- › Thermostat with safety arrest at high temperatures.
- › Encapsulated airend with ROTAIR design profile, max efficiency and operational safety.
- › High efficiency trapezoidal belt-drive, easy to supply and over-dimensioned to ensure transmission with less maintenance.

Technical Data

dimensions >

L = 1125 mm / 44.29"

W = 775 mm / 30.5"

H = 1015 mm / 39.94"

weight >

230 kg / 507 lbs

VRK 16»22



NEW!

VRK 16 AE			VRK 20 AE			VRK 22 AE (only EXTRA CEE)		
6 bar 87 psi	11 bar 160 psi	13 bar 188 psi	6 bar 87 psi	11 bar 160 psi	13 bar 188 psi	6 bar 87 psi	11 bar 160 psi	13 bar 188 psi
1600 l/min 57 cfm	1100 l/min 39 cfm	950 l/min 34 cfm	1900 l/min 67 cfm	1250 l/min 44 cfm	1100 l/min 39 cfm	2150 l/min 76 cfm	1500 l/min 53 cfm	1200 l/min 42 cfm
5,5 bar 80 psi	5,5 bar 80 psi	5,5 bar 80 psi	5,5 bar 80 psi	5,5 bar 80 psi	5,5 bar 80 psi	5,5 bar 80 psi	5,5 bar 80 psi	5,5 bar 80 psi

Belt-drive XPZ overdimensioned

Air / Oil

5 lt / 1.1 UK gal

20°C / 68°F + ambient temperature

1 x 3/4"

< 97 LWA

12V cc - 330A-45Ah (EN)

15 lt / 3.3 UK gal

VRK 16 AE	VRK 20 AE	VRK 22 AE (only EXTRA CEE)
-----------	-----------	----------------------------

HONDA

GX 630	GX 690	
4 strokes	4 strokes	
Stage V	Stage V	Stage V
690 cc	690 cc	
2	2	
Natural	Natural	
15.5 kW-20.8 HP	16.5 kW-22.5 HP	
3000 RPM	3000 RPM	3400 RPM
2000 RPM	2000 RPM	
Air	Air	
Oil	Oil	
1,9 lt / 0.42 UK gal	1,9 lt / 0.42 UK gal	

-10°C > +50°C / 14°F > 122° F

1800 m a.s.l.

- › Pneumatic control system, ROTAIR production, to automatically adjust engine revs, depending on the air to be delivered. This system is highly reliable and ensures fuel consumption savings.
- › Encapsulated separator tank with double separation-internal filter and external spin-on: oil carry-over 1-3 PPM
- › Air/oil separator filter, highly oversized, to guarantee an excellent air/oil separation.
- › Compressor oil filter and engine oil filter are separated.
- › Single stage oversized air filter for compressor part, to guarantee good filtering of the air intaken by airend.



ROTAIR®



Worldwide
VERSION



*Different features or tech specs may apply
for the European version of this model*

supersilent ›

VRH

powerful › compact

10››70



- › Screw compressor driven by hydraulic motor usually mounted on excavators and hydraulic operating machines for all necessities of compressed air.
- › Different operating pressures available.
- › Robust, extremely compact and reliable made on purpose to be installed in the shape of carriers - no impact on balance - ground inclination does not matter
- › Clean layout / easy maintenance.
- › Parker hydraulic motors.
- › Electric equipment 12V or 24V.
- › Saving on fuel costs and less maintenance needed.



Technical DATA

	OPERATING PRESSURE	AIR DELIVERY	OIL FLOW	OIL PRESSURE	Dimensions (L x L x H)	WEIGHT
VRH10	8 - 10 - 13 bar 116 -145 - 189 PSI	1100 lt/min 39 CFM	from 30 to 60 lt/min from 6 to 13 Gpm	from 120 to 205 bar from 1740 to 2973 PSI	696 x 810 x 704 mm 27,4 x 31,89 x 27,72 inches	185 kg 407 lbs
VRH11	7 - 8 bar 100 - 116 PSI	1000 lt/min 35 CFM	from 55 lt/min from 12 Gpm	from 125 to 130 bar from 1813 to 1885 PSI	580 x 905 x 550 mm 22,83 x 33,46 x 21,65 inches	185 kg 407 lbs
VRH15	8 - 10 - 13 bar 116 -145 - 189 PSI	1500 lt/min 53 CFM	from 45 to 85 lt/min from 10 to 19 Gpm	from 120 to 200 bar from 1740 to 2900 PSI	696 x 910 x 704 mm 27,4 x 31,89 x 27,72 inches	185 kg 407 lbs
VRH20	8 - 10 - 13 bar 116 -145 - 189 PSI	2000 lt/min 70 CFM	from 60 to 105 lt/min from 13 to 23 Gpm	from 105 to 215 bar from 1522 to 3118 PSI	696 x 910 x 704 mm 27,4 x 31,89 x 27,72 inches	225 kg 495 lbs
VRH25	8 - 10 - 13 bar 116 -145 - 189 PSI	2500 lt/min 88 CFM	from 70 to 120 lt/min from 15 to 26 Gpm	from 115 to 240 bar from 1668 to 3480 PSI	696 x 910 x 704 mm 27,4 x 31,89 x 27,72 inches	225 kg 495 lbs
VRH30	8 - 10 - 13 bar 116 -145 - 189 PSI	3000 lt/min 106 CFM	from 60 to 135 lt/min from 13 to 30 Gpm	from 110 to 240 bar from 1595 to 3480 PSI	696 x 910 x 704 mm 27,4 x 31,89 x 27,72 inches	225 kg 495 lbs
VRH35	7 - 8 bar 100 -116 PSI	3500 lt/min 124 CFM	from 110 to 150 lt/min from 24 to 33 Gpm	from 110 to 160 bar from 1595 to 2320 PSI	696 x 910 x 704 mm 27,4 x 31,89 x 27,72 inches	225 kg 495 lbs
VRH40	8 - 10 bar 116 -145 PSI	4000 lt/min 141 CFM	from 100 to 165 lt/min from 22 to 36 Gpm	from 130 to 215 bar from 1885 to 3118 PSI	793 x 966 x 874 mm 31,22 x 38 x 34,4 inches	350 kg 770 lbs
VRH50	7 - 8 bar 100 -116 PSI	5000 lt/min 177 CFM	from 135 to 180 lt/min from 30 to 40 Gpm	from 115 to 190 bar from 1668 to 2755 PSI	793 x 966 x 874 mm 31,22 x 38 x 34,4 inches	350 kg 770 lbs
VRH55	7 - 8 bar 100 -116 PSI	5500 lt/min 195 CFM	from 135 to 200 lt/min from 30 to 44 Gpm	from 120 to 180 bar from 1740 to 2610 PSI	793 x 966 x 874 mm 31,22 x 38 x 34,4 inches	350 kg 770 lbs
VRH60	8 - 10 bar 116 -145 PSI	6000 lt/min 212 CFM	from 110 to 205 lt/min from 24 to 45 Gpm	from 165 a to 235 bar from 2393 to 3408 PSI	820 x 1325 x 1057 mm 32,28 x 52,16 x 41,61 inches	660 kg 1452 lbs
VRH70	7 - 8 bar 100 -116 PSI	7000 lt/min 247 CFM	from 160 to 215 lt/min from 35 to 45 Gpm	from 170 to 215 bar from 2465 to 3118 PSI	820 x 1325 x 1057 mm 32,28 x 52,16 x 41,61 inches	660 kg 1452 lbs

hydraulic transmission compressors

we are focused on

SAND BLASTING MODE

AFTER COOLED SANDBLASTING

All models of **ROTAIR** compressors have specific aftercooled versions.

They feature an additional cooler to cool down compressed air and a specific condensate separator, that drains the water produced by the thermic exchange of the cooler.

This gives a cooler output of compressed air ($\text{ambient} +12 \pm 2^{\circ}\text{C}$) and significantly lowers the humidity of the air, although not removing completely the moisture from air, as this depends mainly on the environmental conditions.

INBUILT ADDITIONAL COOLER AND SPECIFIC CONDENSATE SEPARATOR

for cool and dry air

specifically
designed for...



The aftercooled versions are called "**SANDBLASTING**" because the main use of these machines finds its operation in the sandblasting sector. These machines are indicated for all operations that are sensitive to humidity of the air output: optic fibre laying, use of pneumatic tools that are sensitive to humidity. **ROTAIR** also offers an **EXTERNAL "BS" AFTER-COOLER SYSTEM**, easy to connect through an air pipe kit and is electrically powered by the compressor.

It enables standard compressors, from 2000 to 8500 lt/min (71 to 300 cfm) to work in sandblasting and other humidity-sensitive operations. Air output temperature is extremely low: ambient +2°C. Humidity in air suffers a drastic diminution. The unit is on wheels, easy to transport and to handle, built to meet the most exigent and severe working conditions.

ROTAIR OFFERS A BROAD PANEL OF TRAILERS, TO MAKE COMPRESSORS EFFECTIVELY PORTABLE.

The undercarriage of a portable compressor is composed of:

AXLE

The part connecting compressor to the ground, includes suspension system, wheels and all related parts. Suspensions can be assured with springs (sprung axle) or leaf springs (leaf spring axle). Wheels are of different size, to match the weight of the machine and according to the type of towing.

LIGHTS

System of rear lights and reflectors

BRAKING SYSTEMS

Can be with no braking system at all, simple parking brake or repulsion braking system.

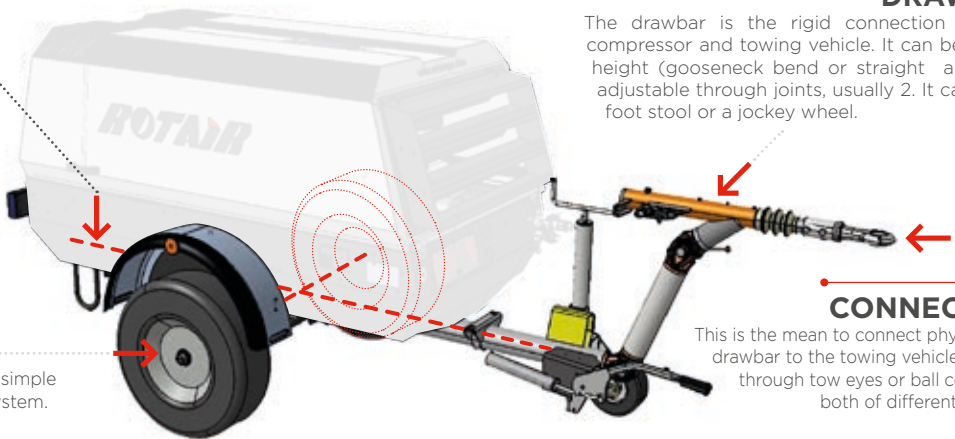

DRAWBAR

The drawbar is the rigid connection between compressor and towing vehicle. It can be at fixed height (gooseneck bend or straight angles) or adjustable through joints, usually 2. It can have a foot stool or a jockey wheel.

CONNECTION

This is the mean to connect physically the drawbar to the towing vehicle. It can be through tow eyes or ball connection, both of different diameter.

STANDARD TRAILER - MDVN

So-called "gooseneck" for the peculiar shape of the drawbar. Is always without brakes. Enables slow towing (max 25 km/h) on work field but not on public roads.

TRAILER WITH BRAKES - MDVN

Has adjustable drawbar, repulsive braking system, lights. Enables compressor to be towed on public roads, if homologated.

STANDARD TRAILER - MDVS

Has adjustable drawbar. Is without repulsive braking system, but has a parking brake. Enables slow towing (max 25 km/h) on work field but not on public roads.

TRAILER WITH BRAKES - MDVS

Has adjustable drawbar, repulsive braking system, lights. Enables compressor to be towed on public roads, if homologated.

TRAILER WITH PARKING BRAKE

All types of axles and drawbars can be equipped with parking brake, a lever that blocks the wheels when the machine must be static.

SKID ADAPTOR

Portable compressors can be delivered "ON SKID", which means without wheels but on a base with four support feet.

ROTAIR has a special SKID ADAPTOR, used to prepare the machine for standard skid delivery, that can be provided as separate attachment and be used to transform a towable compressor into a skid compressor. Viceversa: by removing the skid adaptor and installing an undercarriage with all its parts, the original skid machine can become towable.



ON ROAD HOMOLOGATION / To circulate on public roads, towed by a vehicle, a portable compressor needs to have several characteristics.

EUROPE:

European Union has uniformed the legislation to enable towing of trailers, among those portable compressors. To be towed on public roads, a trailer shall respond to Directive 2007/46/CE. The manufacturer shall undergo a process of internal homologation by one European Ministry of transports and all machines to be towed shall be examined and approved. The exam includes the presence of all elements requested by the Directive (among others: braking system where needed, lights, reflectors, etc...). This done, the manufacturer will be issued, for each towable model, a unique reference number, that will be engraved on the chassis of the machines deemed to be towed and integrated into the specific documentation of the machine. This number, communicated by the end Customer to the Office of Circulation of the European Country where the machine will be put into operation, will enable the road homologation process without need of further presentation of documents or physical inspection and assessment by the competent Authority.

OTHER COUNTRIES.

For other Countries outside Europe, the local legislation shall be followed. ROTAIR can provide, upon request, the specific documents and drawings that could be requested for a national road homologation. The Dealer or end Customer shall provide the specifications that the machines shall respect to be homologated. In some cases, the Dealer could modify the machines, upon authorization of ROTAIR, to conform them to the norms of the reference Country.

FEATURED HIGHLIGHTS

EXCLUSIVE ROTAIR INTELLIGENT SYSTEM

THE "INTELLIGENT SYSTEM" ENABLES A PRE-HEATING OF THE ENGINE WITHOUT OVERLOADING IT, THE AIREND WILL START WORKING ONLY WHEN THE PERFECT CONDITIONS ARE REACHED.

THE SAME IN TURNING OFF THE MACHINE AFTER A DEPRESSURISATION PHASE OF THE HYDRAULIC CIRCUIT, NO HAMMERING OF THE AIREND DUE TO ITS INERTIAL MOVEMENT, BUT A GRADUAL TURN-OFF.



No more need to start the machine with the air exit open (and risks of forgetting it)

All this brings:

- A correct lubrication to the screw set and the engine, even in extremely cold temperature conditions.
- A better functioning and a higher durability of all the components of the machine.
- An increase of the separator filter lifetime and no oil in the air during the next compressor's starts (and no black smoke from the exhausts pipe while turning the machine on).

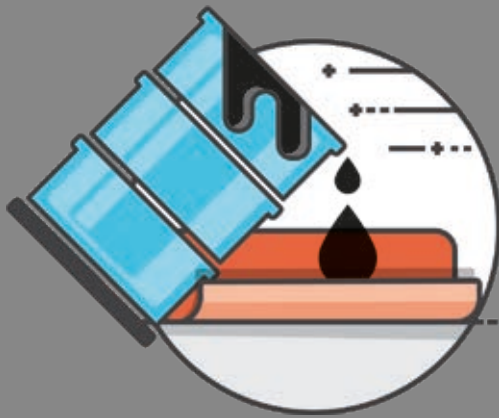

BUNDED CHASSIS ADAPTER

This exclusive device, only for ROTAIR portable compressors, offers the possibility to have your compressor protected from accidental spills of fluids on the ground.

Removable yet solidly fixable to the compressor, it is the ultimate option where anti-spill is mandatorily required.

It is so intelligent that it enables forklift handling of the compressor.

EASY MAINTENANCE

FULL ACCESSIBILITY FOR EASY AND RAPID MAINTENANCE AND SERVICE

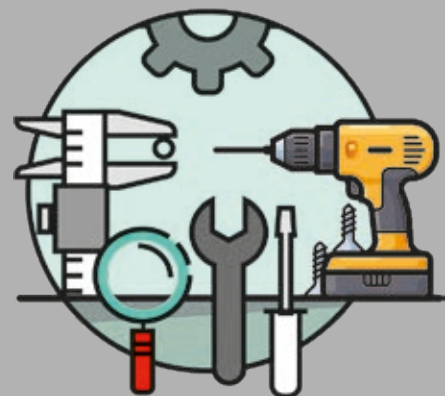

PORTABLE



COMPRESSORS

**WARRANTY,
DURATION and
RELIABILITY**

are assured with
THE EXCLUSIVE USE
of original spare parts.



www.rotairspa.com



© 2020 | ALL RIGHTS RESERVED

DELIVERING **WORLD CLASS**
Compressed Air Solutions



ROTAIR[®]



PORTABLE 
COMPRESSORS

**SCREW
SUPERSILENT**
for civil
engineering
&
MUCH MORE



ROTAIR[®]

VIA BERNEZZO, 67
12023 ▶ CARAGLIO (CN) ▶ ITALY



Tel: +39 0171.619676
Fax: +39 0171.619677

» www.rotairspa.com
info@rotairspa.com

Azienda certificata
ISO 9001:2015



ROTAIR - A brand of ELGI Equipments Ltd.

Amin Power Energy

Zielone Wzgórze 6
67-210 Głogów, Poland

tel. +48 76 742 83 20
mob. +48 691442270

rotair@powerenergy.com.pl

